

Varenummer: 0108042
 Beskrivelse: Seeger låsering JK 25 DIN 984

Mål

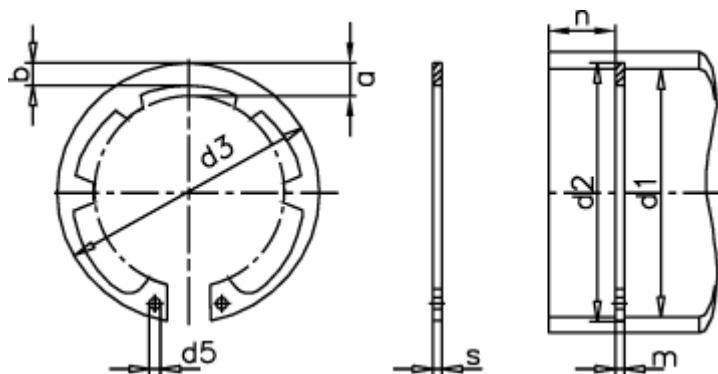

a max	= 4.4	d5 min	= 2.0	s	= 1.20
AN mm ²	= 48.2	FN kN	= 8.0	t	= 0.60
Antal takker	= 6	FRg kN	= 4.7	Tang	= ZGJ-2
b	= 2.8	FR kN	= 14.6	tol	= -0.06
Betegnelse	= JK 25	g	= 1.0	tol	= +0,42-0,21
d1	= 25	K kN-mm	= 29.0	tol	= +0,21
d2	= 26.2	m min	= 1.30	vægt kg/1000	= 1.72
d3	= 26.9	Nominal træk	= 1.8		